

# Data Sheet

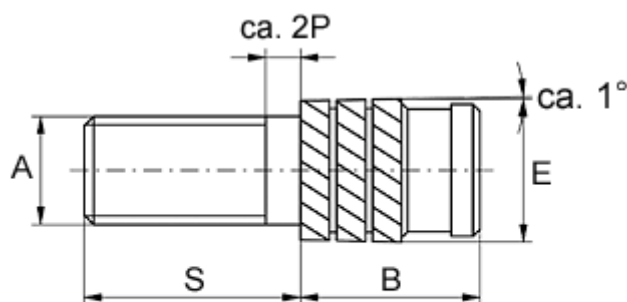

Article number: 12856000080860  
Description: KLEE-coil 856 000 080.860  
M8 Brass

## Measures



Gevindlængde =  $S - 2P$   
P = stigning

Male thread A	= M8x1,25
Min distance to edge	= 3.8
Mounting length B	= 9.2
Outer diameter E	= 9.70
Pin length S	= 16
Recommended bore diameter	= 9.3
Type	= 856 000 080.860